

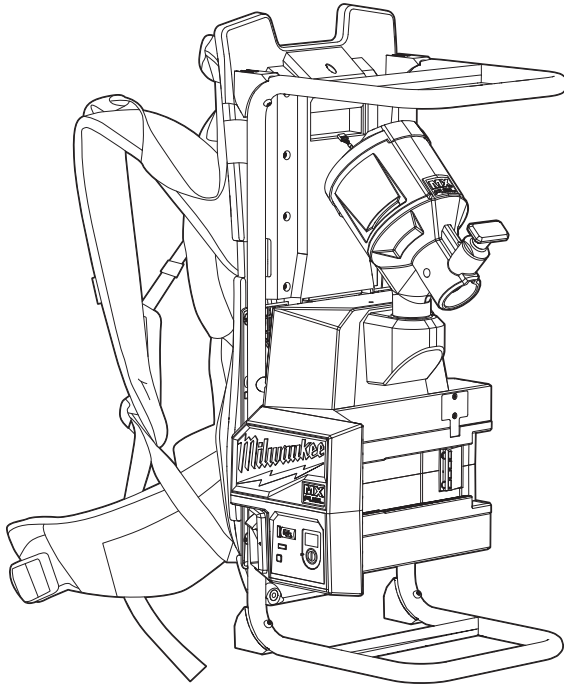



OPERATOR'S MANUAL



Cat. No.
MXF CVBP

MX FUEL™ BACKPACK CONCRETE VIBRATOR

 **WARNING**

 To reduce the risk of injury, user must read and understand operator's manual.

GENERAL POWER TOOL SAFETY WARNINGS

⚠WARNING Read all safety warnings, instructions, illustrations and specifications provided with this power tool. Failure to follow all instructions listed below may result in electric shock, fire and/or serious injury. **Save all warnings and instructions for future reference.** The term "power tool" in the warnings refers to your mains-operated (corded) power tool or battery-operated (cordless) power tool.

WORK AREA SAFETY

- **Keep work area clean and well lit.** Cluttered or dark areas invite accidents.
- **Do not operate power tools in explosive atmospheres, such as in the presence of flammable liquids, gases or dust.** Power tools create sparks which may ignite the dust or fumes.
- **Keep children and bystanders away while operating a power tool.** Distractions can cause you to lose control.

ELECTRICAL SAFETY

- **Power tool plugs must match the outlet. Never modify the plug in any way. Do not use any adaptor plugs with earthed (grounded) power tools.** Unmodified plugs and matching outlets will reduce risk of electric shock.
- **Avoid body contact with earthed or grounded surfaces, such as pipes, radiators, ranges and refrigerators.** There is an increased risk of electric shock if your body is earthed or grounded.
- **Do not expose power tools to rain or wet conditions.** Water entering a power tool will increase the risk of electric shock.
- **Do not abuse the cord. Never use the cord for carrying, pulling or unplugging the power tool. Keep cord away from heat, oil, sharp edges or moving parts.** Damaged or entangled cords increase the risk of electric shock.
- **When operating a power tool outdoors, use an extension cord suitable for outdoor use.** Use of a cord suitable for outdoor use reduces the risk of electric shock.
- **If operating a power tool in a damp location is unavoidable, use a residual current device (RCD) protected supply.** Use of a RCD reduces the risk of electric shock.

PERSONAL SAFETY

- **Stay alert, watch what you are doing and use common sense when operating a power tool. Do not use a power tool while you are tired or under the influence of drugs, alcohol or medication.** A moment of inattention while operating power tools may result in serious personal injury.
- **Use personal protective equipment. Always wear eye protection marked to comply with AS/NZS 1337.1.** Protective equipment such as a dust mask, non-skid safety shoes, hard hat or hearing protection used for appropriate conditions will reduce personal injuries.
- **Prevent unintentional starting. Ensure the switch is in the off-position before connecting to power source and/or battery pack, picking up or carrying the tool.** Carrying power tools with your finger on the switch or energising power tools that have the switch on invites accidents.

- **Remove any adjusting key or wrench before turning the power tool on.** A wrench or a key left attached to a rotating part of the power tool may result in personal injury.
- **Do not overreach. Keep proper footing and balance at all times.** This enables better control of the power tool in unexpected situations.
- **Dress properly. Do not wear loose clothing or jewellery. Keep your hair and clothing away from moving parts.** Loose clothes, jewellery or long hair can be caught in moving parts.
- **If devices are provided for the connection of dust extraction and collection facilities, ensure these are connected and properly used.** Use of dust collection can reduce dust-related hazards.
- **Do not let familiarity gained from frequent use of tools allow you to become complacent and ignore tool safety principles.** A careless action can cause severe injury within a fraction of a second.

POWER TOOL USE AND CARE

- **Do not force the power tool. Use the correct power tool for your application.** The correct power tool will do the job better and safer at the rate for which it was designed.
- **Do not use the power tool if the switch does not turn it on and off.** Any power tool that cannot be controlled with the switch is dangerous and must be repaired.
- **Disconnect the plug from the power source and/ or remove the battery pack, if detachable, from the power tool before making any adjustments, changing accessories, or storing power tools.** Such preventive safety measures reduce the risk of starting the power tool accidentally.
- **Store idle power tools out of the reach of children and do not allow persons unfamiliar with the power tool or these instructions to operate the power tool.** Power tools are dangerous in the hands of untrained users.
- **Maintain power tools and accessories. Check for misalignment or binding of moving parts, breakage of parts and any other condition that may affect the power tool's operation. If damaged, have the power tool repaired before use.** Many accidents are caused by poorly maintained power tools.
- **Keep cutting tools sharp and clean.** Properly maintained cutting tools with sharp cutting edges are less likely to bind and are easier to control.
- **Use the power tool, accessories and tool bits etc. in accordance with these instructions, taking into account the working conditions and the work to be performed.** Use of the power tool for operations different from those intended could result in a hazardous situation.
- **Keep handles and grasping surfaces dry, clean and free from oil and grease.** Slippery handles and grasping surfaces do not allow for safe handling and control of the tool in unexpected situations.

BATTERY TOOL USE AND CARE

- **Recharge only with the charger specified by the manufacturer.** A charger that is suitable for one type of battery pack may create a risk of fire when used with another battery pack.
- **Use power tools only with specifically designated battery packs.** Use of any other battery packs may create a risk of injury and fire.

•When battery pack is not in use, keep it away from other metal objects, like paper clips, coins, keys, nails, screws or other small metal objects, that can make a connection from one terminal to another. Shorting the battery terminals together may cause burns or a fire.

•Under abusive conditions, liquid may be ejected from the battery; avoid contact. If contact accidentally occurs, flush with water. If liquid contacts eyes, additionally seek medical help. Liquid ejected from the battery may cause irritation or burns.

•Do not use a battery pack or tool that is damaged or modified. Damaged or modified batteries may exhibit unpredictable behaviour resulting in fire, explosion or risk of injury.

•Do not expose a battery pack or tool to fire or excessive temperature. Exposure to fire or temperature above 130°C (265°F) may cause explosion.

•Follow all charging instructions and do not charge the battery pack or tool outside the temperature range specified in the instructions. Charging improperly or at temperatures outside the specified range may damage the battery and increase the risk of fire.

SERVICE

•Have your power tool serviced by a qualified repair person using only identical replacement parts. This will ensure that the safety of the power tool is maintained.

•Never service damaged battery packs. Service of battery packs should only be performed by the manufacturer or authorised service providers.

SPECIFIC SAFETY RULES FOR BACKPACK CONCRETE VIBRATOR

•Do not use accessories which are not specifically designed and specified by the tool manufacturer. Just because the accessory can be attached to your power tool, it does not assure safe operation.

•Always install flex shaft and head according to the manufacturer's instructions. Only use accessories matching the tool coupler.

•Chemical Burn Hazard. Keep coin cell battery away from children.

•Always use common sense and be cautious when using tools. It is not possible to anticipate every situation that could result in a dangerous outcome. Do not use this tool if you do not understand these operating instructions or you feel the work is beyond your capability; contact MILWAUKEE® Tool or a trained professional for additional information or training.

•Maintain labels and nameplates. These carry important information. If unreadable or missing, contact a MILWAUKEE® service facility for a replacement.

AWARNING Some dust created by power sanding, sawing, grinding, drilling, and other construction activities contains chemicals known to cause cancer, birth defects or other reproductive harm. Some examples of these chemicals are:

- lead from lead-based paint
- crystalline silica from bricks and cement and other masonry products, and
- arsenic and chromium from chemically-treated lumber.

Your risk from these exposures varies, depending on how often you do this type of work. To reduce your exposure to these chemicals: work in a well ventilated











area, and work with approved safety equipment, such as those dust masks that are specially designed to filter out microscopic particles.

ADDITIONAL BATTERY SAFETY RULES

AWARNING To reduce the risk of fire, personal injury, and product damage due to a short circuit, never immerse your tool, battery pack or charger in fluid or allow a fluid to flow inside them. Corrosive or conductive fluids, such as seawater, certain industrial chemicals, and bleach or bleach-containing products, etc., can cause a short circuit.

AWARNING Do not charge non-rechargeable batteries.

SYMBOLGY

-  Volts
-  Direct Current
- n XXXX min⁻¹ Vibrations per Minute (VPM)
-  Read operator's manual
-  Wear personal protective equipment (PPE) according to the job site requirements.
-  Wear eye protection
-  Pairing
-  Cold Start LED
-  Remote mode
-  OFF position
-  ON position
-  Regulatory Compliance Mark (RCM). This product meets applicable regulatory requirements.
- Do not dispose of electric tools together with household waste material. Electric tools and electronic equipment that have reached the end of their life must be collected separately and returned to an environmentally compatible recycling facility.

SPECIFICATIONS

Cat. No.	MXF CVBP
Battery Type	MX FUEL™
Charger Type	MX FUEL™
Recommended Ambient Charging Temperature	5°C to 40°C
MX FUEL™ Li-Ion Battery Packs	72V DC
Rated VPM	11,200
MILWAUKEE® Flex Shafts and Heads	
2.1 m (7') Flex Shaft	Cat. No. MXF CVS-21M
4.2 m (14') Flex Shaft	Cat. No. MXF CVS-42M
38 mm (1-1/2") Head.....	Cat. No. MXF CVH-38MM
50 mm (2") Head.....	Cat. No. MXF CVH-50MM
Remote Cat. No.	22800237
Communication Range	Up to 9 m
Battery Type.....	2xAAA

FUNCTIONAL DESCRIPTION

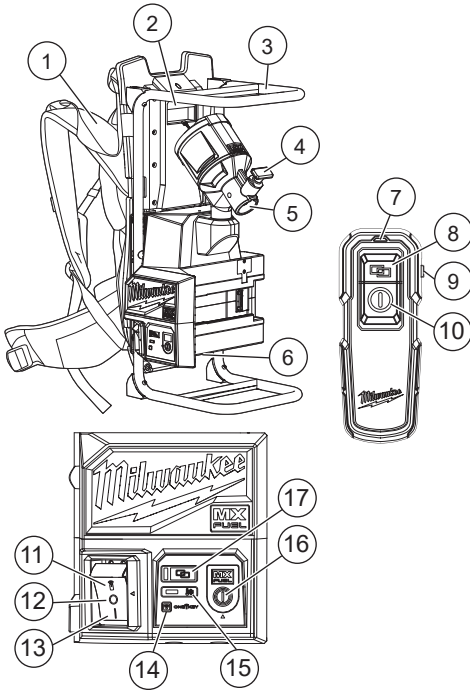

1. Backpack
2. Backpack latch
3. Carry handle
4. Coupler locking handle
5. Flex shaft coupler
6. Remote storage
7. Transmit LED
8. Pairing button
9. Remote on/off switch
10. Start/Stop button
11. Remote mode position
12. OFF position
13. ON position
14. ONE-KEY indicator
15. Cold Start LED
16. Arm button
17. Pairing button

ASSEMBLY

⚠WARNING Recharge only with the charger specified for the battery. For specific charging instructions, read the operator's manual supplied with your charger and battery.

Removing/Inserting the Battery

To **remove** the battery, push the battery latch lock to the side and squeeze the battery latch lever. Pull the battery pack away from the machine.

⚠WARNING Always remove battery pack before changing or removing accessories.

To **insert** the battery, slide the pack into the body of the machine. Make sure it latches securely into place.

⚠WARNING Only use accessories specifically recommended for this machine. Others may be hazardous.

Attaching the Flex Shaft

Flex shafts are normally lubricated from the manufacturer from one end. Attach the greased end to the machine. Use a flex shaft with a length suitable for the job.

1. Remove the battery pack.

⚠WARNING Always remove battery pack before changing or removing accessories.

2. Open coupler locking handle.

3. Place the flex shaft into the coupler.

4. Pull the flex shaft until the coupler locking handle engages. (Handle will automatically fall into place with an audible click)

Attaching Head to Flex Shaft

1. Remove the battery pack.

⚠WARNING Always remove battery pack before changing or removing accessories.

2. Coat flex shaft threads with sealant to prevent water from entering head

3. Thread head onto flex shaft.

4. Tighten by gripping metal portion of the flex shaft and flats of the head.

Putting on the Backpack

1. Ensure backpack is securely latched to base.

2. Pick up the backpack by one of the shoulder straps, slide your arms through each shoulder strap.

3. With the machine on your back, tighten the shoulder and waist straps until they fit snugly and securely. Connect chest strap.

4. Be sure the shoulder, chest, and waist straps are tight but comfortable; if they are too loose, the machine may slide around on your back, making it uncomfortable to wear.

5. Be aware machine forces may shift during use and movement, such as twisting or bending over.

Changing Remote Batteries

Only use alkaline batteries. Do not use zinc-carbon batteries. If the remote will not be used for a long time, remove the batteries as a protection against corrosion.

To change the batteries:

1. Open the battery compartment.

2. Insert the batteries according to the polarity marked in the compartment.

3. Close the battery compartment.

Pairing the Remote

1. Arm the machine.

2. On the machine, set the switch to the  position.

3. Turn on the remote.

4. On the machine, press and hold the  button until LED begins flashing (indicating machine is ready to pair).

5. Press and hold the  button on the Remote; flashing LED on machine will turn solid then off when the remote has paired successfully.

NOTE: Remote needs to be within close proximity to ensure remote is receiving signal from the machine. This procedure will time out in 30 seconds if machine is not paired.

Removing/Installing the Backpack

The backpack can be removed for certain applications or for spot cleaning.

To **remove** the backpack, squeeze the backpack latch and pull the backpack away from the machine.

NOTE: When used without a backpack, do not drag the machine with the flexible shaft.

To **install** the backpack, line up the bottom hook and secure the backpack to the machine base using the backpack latch.

ONE-KEY™

To learn more about the ONE-KEY™ functionality for this machine, please refer to the quick reference included with this machine or go to onekey.milwaukeeool.com.au / onekey.milwaukeeool.com.nz. To download the ONE-KEY™ app, visit the App Store or Google Play from your smart device.

ONE-KEY™ Indicator	
Solid Blue	Wireless mode is active and ready to be configured via the ONE-KEY™ app.
Blinking Blue	Machine is actively communicating with the ONE-KEY™ app.
Blinking Red	Machine is in security lockout and can be unlocked by the owner via the ONE-KEY™ app.

OPERATION

⚠ WARNING To reduce the risk of injury, always wear proper eye protection marked to comply with AS/NZS 1337.1.

Arming the Machine

The MX FUEL™ machines must be armed prior to use. Even with the battery pack inserted, the machine functions will not operate until the machine is armed. To arm the machine:

1. Insert the battery pack.
2. Press the Arm button. The MX FUEL™ symbol will illuminate.
3. After 15 minutes of inactivity, the machine will enter sleep mode. The MX FUEL™ symbol and other operational LED's will no longer be illuminated.
4. Press and hold the Arm button for 1 second to reactivate the machine.
5. Press and hold the ARM button for 1 second to unarm (turn off) the machine. The MX FUEL™ symbol will go off.

Starting and Stopping

1. Arm the machine.
2. To **start** the machine, set the switch to the **I** position.
3. To **stop** the machine, set the switch to the **O** position.

Starting and Stopping (Remote Mode)

1. Arm the machine.
2. On the machine, set the switch to the **R** position.
3. Turn on the remote
4. To **start** the machine, press the **Ⓜ** button on the remote.
5. To **stop** the machine, press the **Ⓜ** button on the remote.

Cold Start LED

The Cold Start LED will illuminate when the machine is started in cold conditions (below 0°C). The machine will gradually bring the VPM up to 10,000 in order to avoid nuisance shut downs. Once the VPM reaches 10,000 VPM the Cold Start LED will go off. This feature allows the machine to start in temps as low as -20°C.

Low Battery Alert

During use, when the battery nears end of charge (at 10% and 2% remaining charge), the machine will notify the user by turning itself off and on (pausing). Remove the battery from the backpack and charge the battery with a MX FUEL™ battery charger.

General Operation

1. Turn the unit on before putting head in material.
2. Insert the head vertically into material allowing the head to sink to desired depth by its own weight.
3. Hold in place for 5-15 seconds, then slowly lift head up, keeping the shaft and head in front of your operating position, while staying behind the trapped air's movement to avoid retrapping air.
4. A small up and downward movement will close the hole formed by the head.
5. To prevent agitating air into material, withdraw the head quickly when near the top. Move head, re-insert and repeat as desired.
6. When task is completed, remove head from material, then turn machine off.

⚠ CAUTION If machine is turned off before removing head from material, head will be difficult to remove.

⚠ CAUTION Material may spray once head is removed and prior to machine being turned off. Turn machine off as quickly as possible once head removed from material.



MAINTENANCE

⚠WARNING To reduce the risk of injury, always unplug the charger and remove the battery pack from the charger or machine before performing any maintenance. Never disassemble the machine, battery pack or charger. Contact a MILWAUKEE® service facility for ALL repairs.

Maintaining Machine

Keep your machine, battery pack and charger in good repair by adopting a regular maintenance program. Inspect your machine for issues such as undue noise, misalignment or binding of moving parts, breakage of parts, or any other condition that may affect the machine operation. Return the machine, battery pack, and charger to a MILWAUKEE® service facility for repair. After six months to one year, depending on use, return the machine, battery pack and charger to a MILWAUKEE® service facility for inspection.

If the machine does not start or operate at full power with a fully charged battery pack, clean the contacts on the battery pack. If the machine still does not work properly, return the machine, charger and battery pack, to a MILWAUKEE® service facility for repairs.

ONE-KEY™

⚠WARNING Chemical Burn Hazard. This device contains a lithium button/coin cell battery. A new or used battery can cause severe internal burns and lead to death in as little as 2 hours if swallowed or enters the body. Always secure the battery cover. If it does not close securely, stop using the device, remove the batteries, and keep it away from children. If you think batteries may have been swallowed or entered the body, seek immediate medical attention.



Internal Battery

An internal battery is used to facilitate full ONE-KEY™ functionality.

To replace the battery:

1. Remove the battery pack.
2. Remove the screw(s) and open the battery door.
3. Remove the old battery, keep it away from children, and dispose of it properly.
4. Insert the new battery (3V CR2032), with the positive side facing up.
5. Close the battery door and tighten the screw(s) securely.

⚠WARNING To reduce the risk of personal injury, electric shock and damage, never immerse your machine in liquid or allow a liquid to flow inside it.

Cleaning

Clean dust and debris from vents. Keep handles clean, dry and free of oil or grease. Use only mild soap and a damp cloth to clean, since certain cleaning agents and solvents are harmful to plastics and other insulated parts. Some of these include gasoline, turpentine, lacquer thinner, paint thinner, chlorinated cleaning solvents, ammonia and household detergents containing ammonia. Do not spray the machine or battery. Never use flammable or combustible solvents around machines.

Cleaning the Battery and Battery Bay

Keep battery connections and surfaces between the machine and battery free of debris and materials. Failure to keep surfaces clean may result in misalignment and/or damage to the battery connection.

Repairs

For repairs, return the machine to the nearest service centre.

ACCESSORIES

⚠WARNING Use only recommended accessories. Others may be hazardous.

For a complete listing of accessories, go online to www.milwaukeetool.com.au/ or www.milwaukeetool.co.nz or contact a distributor.

WARRANTY - AUSTRALIA and NEW ZEALAND

Please refer to Australian and New Zealand warranty supplied with tool. This warranty applies only to product sold by authorised dealers in Australia and New Zealand.

SERVICE - AUSTRALIA and NEW ZEALAND

MILWAUKEE® prides itself in producing a premium quality product that is Nothing But Heavy Duty™. Your satisfaction with our products is very important to us! If you encounter any problems with the operation of this tool, please contact your authorised **MILWAUKEE®** dealer.

For a list of **MILWAUKEE®** dealers, guarantee or service agents please contact **MILWAUKEE®** Customer Service or visit our website.

(Australia Toll Free Telephone Number 1300 645 928)

(New Zealand Toll Free Telephone Number 0800 645 928)

or visit milwaukeetool.com.au/milwaukeetool.co.nz.

Milwaukee Electric Tool Corporation

13135 West Lisbon Road, Brookfield, Wisconsin U.S.A. 53005

Milwaukee Tool (Australia)

26 - 40 Nina Link, Dandenong South,
Victoria, 3175, Australia

Milwaukee Tool (New Zealand)

274 Church Street, Penrose,
Auckland, 1061, New Zealand

DESIGNED BY MILWAUKEE ELECTRIC TOOL CORP.

PROFESSIONALLY MADE IN U.S.A.

PRINTED IN U.S.A.