

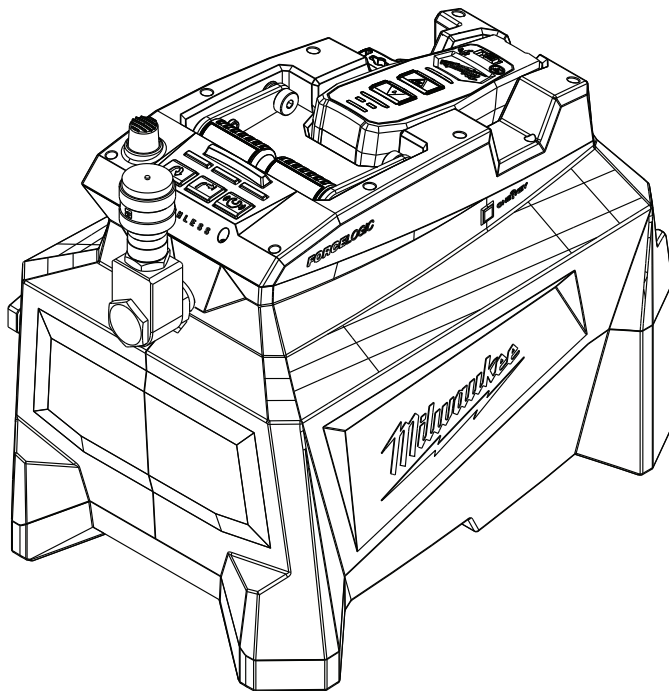

# OPERATOR'S MANUAL



Cat. No.  
**M18 HUP700R**

**M18™ FORCE LOGIC™ 10,000 PSI HYDRAULIC PUMP**

 **WARNING**

To reduce the risk of injury, user must read and understand operator's manual.



## GENERAL POWER TOOL SAFETY WARNINGS

**⚠WARNING** Read all safety warnings, instructions, illustrations and specifications provided with this power tool. Failure to follow all instructions listed below may result in electric shock, fire and/or serious injury. **Save all warnings and instructions for future reference.** The term "power tool" in the warnings refers to your mains-operated (corded) power tool or battery-operated (cordless) power tool.

### WORK AREA SAFETY

- **Keep work area clean and well lit.** Cluttered or dark areas invite accidents.
- **Do not operate power tools in explosive atmospheres, such as in the presence of flammable liquids, gases or dust.** Power tools create sparks which may ignite the dust or fumes.
- **Keep children and bystanders away while operating a power tool.** Distractions can cause you to lose control.

### ELECTRICAL SAFETY

- **Power tool plugs must match the outlet. Never modify the plug in any way. Do not use any adapter plugs with earthed (grounded) power tools.** Unmodified plugs and matching outlets will reduce risk of electric shock.
- **Avoid body contact with earthed or grounded surfaces, such as pipes, radiators, ranges and refrigerators.** There is an increased risk of electric shock if your body is earthed or grounded.
- **Do not expose power tools to rain or wet conditions.** Water entering a power tool will increase the risk of electric shock.
- **Do not abuse the cord. Never use the cord for carrying, pulling or unplugging the power tool. Keep cord away from heat, oil, sharp edges or moving parts.** Damaged or entangled cords increase the risk of electric shock.
- **When operating a power tool outdoors, use an extension cord suitable for outdoor use.** Use of a cord suitable for outdoor use reduces the risk of electric shock.
- **If operating a power tool in a damp location is unavoidable, use a residual current device (RCD) protected supply.** Use of a RCD reduces the risk of electric shock.

### PERSONAL SAFETY

- **Stay alert, watch what you are doing and use common sense when operating a power tool. Do not use a power tool while you are tired or under the influence of drugs, alcohol or medication.** A moment of inattention while operating power tools may result in serious personal injury.
- **Use personal protective equipment. Always wear eye protection.** Protective equipment such as a dust mask, non-skid safety shoes, hard hat or hearing protection used for appropriate conditions will reduce personal injuries.
- **Prevent unintentional starting. Ensure the switch is in the off-position before connecting to power source and/or battery pack, picking up or carrying the tool.** Carrying power tools with your finger on the switch or energizing power tools that have the switch on invites accidents.

- **Remove any adjusting key or wrench before turning the power tool on.** A wrench or a key left attached to a rotating part of the power tool may result in personal injury.
- **Do not overreach. Keep proper footing and balance at all times.** This enables better control of the power tool in unexpected situations.
- **Dress properly. Do not wear loose clothing or jewelry. Keep your hair and clothing away from moving parts.** Loose clothes, jewelry or long hair can be caught in moving parts.
- **If devices are provided for the connection of dust extraction and collection facilities, ensure these are connected and properly used.** Use of dust collection can reduce dust-related hazards.
- **Do not let familiarity gained from frequent use of tools allow you to become complacent and ignore tool safety principles.** A careless action can cause severe injury within a fraction of a second.

### POWER TOOL USE AND CARE

- **Do not force the power tool. Use the correct power tool for your application.** The correct power tool will do the job better and safer at the rate for which it was designed.
  - **Do not use the power tool if the switch does not turn it on and off.** Any power tool that cannot be controlled with the switch is dangerous and must be repaired.
  - **Disconnect the plug from the power source and/ or remove the battery pack, if detachable, from the power tool before making any adjustments, changing accessories, or storing power tools.** Such preventive safety measures reduce the risk of starting the power tool accidentally.
  - **Store idle power tools out of the reach of children and do not allow persons unfamiliar with the power tool or these instructions to operate the power tool.** Power tools are dangerous in the hands of untrained users.
  - **Maintain power tools and accessories. Check for misalignment or binding of moving parts, breakage of parts and any other condition that may affect the power tool's operation. If damaged, have the power tool repaired before use.** Many accidents are caused by poorly maintained power tools.
  - **Keep cutting tools sharp and clean.** Properly maintained cutting tools with sharp cutting edges are less likely to bind and are easier to control.
  - **Use the power tool, accessories and tool bits etc. in accordance with these instructions, taking into account the working conditions and the work to be performed.** Use of the power tool for operations different from those intended could result in a hazardous situation.
  - **Keep handles and grasping surfaces dry, clean and free from oil and grease.** Slippery handles and grasping surfaces do not allow for safe handling and control of the tool in unexpected situations.
- ### BATTERY TOOL USE AND CARE
- **Recharge only with the charger specified by the manufacturer.** A charger that is suitable for one type of battery pack may create a risk of fire when used with another battery pack.
  - **Use power tools only with specifically designated battery packs.** Use of any other battery packs may create a risk of injury and fire.

- When battery pack is not in use, keep it away from other metal objects, like paper clips, coins, keys, nails, screws or other small metal objects, that can make a connection from one terminal to another. Shorting the battery terminals together may cause burns or a fire.
- Under abusive conditions, liquid may be ejected from the battery; avoid contact. If contact accidentally occurs, flush with water. If liquid contacts eyes, additionally seek medical help. Liquid ejected from the battery may cause irritation or burns.
- Do not use a battery pack or tool that is damaged or modified. Damaged or modified batteries may exhibit unpredictable behavior resulting in fire, explosion or risk of injury.
- Do not expose a battery pack or tool to fire or excessive temperature. Exposure to fire or temperature above 130°C (265°F) may cause explosion.
- Follow all charging instructions and do not charge the battery pack or tool outside the temperature range specified in the instructions. Charging improperly or at temperatures outside the specified range may damage the battery and increase the risk of fire.

### SERVICE

- Have your power tool serviced by a qualified repair person using only identical replacement parts. This will ensure that the safety of the power tool is maintained.
- Never service damaged battery packs. Service of battery packs should only be performed by the manufacturer or authorized service providers.

### SPECIFIC SAFETY RULES FOR REMOTE PUMP

- Inspect pump, hoses, couplers, and fittings for wear or damage. Replace worn, damaged, or missing components with manufacturer's replacement parts. Worn or damaged components can fail, resulting in injury. Failure to observe this warning could result in severe injury or death.
- Ensure pump is in the desired mode of operation before use.
- Do not use hands to check for leaks. High pressure oil easily punctures skin, causing serious injury, gangrene, or death. If injured, seek medical help immediately to remove oil.
- Depressurize hydraulic system before servicing or disconnecting the hose.
- Wear eye protection when operating or servicing this tool. Failure to wear eye protection could result in serious eye injury from flying debris or hydraulic oil.
- Only use hoses and attachments that are single-acting and rated 10,000 psi (700 bar) or higher.
- For best performance, use hoses that are pre-filled with oil. If the hoses are not pre-filled, bleed the system before operating.
- Never operate the pump without a hose or attachment.
- For best performance, always use Hydraulic Oil to refill the reservoir.
- For optimal functionality, use M18™ REDLITHIUM®-ION 8.0 Ah battery or higher.
- Follow accessory manufacturers' operator's manual. Other uses may cause damage to the tool, accessories, and workpiece.

- AWARNING** To reduce the risk of arc flash, electric shock and property damage, work on de-energized lines when possible. Tool is not insulated.  Should work on energized lines be required, ensure all proper precautions have been taken first.
- Always use common sense and be cautious when using tools. It is not possible to anticipate every situation that could result in a dangerous outcome. Do not use this tool if you do not understand these operating instructions or you feel the work is beyond your capability; contact MILWAUKEE® Tool or a trained professional for additional information or training.
- Maintain labels and nameplates. These carry important information. If unreadable or missing, contact a MILWAUKEE® service facility for a replacement.

- AWARNING** Some dust created by power sanding, sawing, grinding, drilling, and other construction activities contains chemicals known to cause cancer, birth defects or other reproductive harm. Some examples of these chemicals are:
  - lead from lead-based paint
  - crystalline silica from bricks and cement and other masonry products, and
  - arsenic and chromium from chemically-treated lumber.
 Your risk from these exposures varies, depending on how often you do this type of work. To reduce your exposure to these chemicals: work in a well ventilated area, and work with approved safety equipment, such as those dust masks that are specially designed to filter out microscopic particles.

### ADDITIONAL BATTERY SAFETY RULES

- AWARNING** To reduce the risk of fire, personal injury , and product damage due to a short circuit, never immerse your tool, battery pack or charger in fluid or allow a fluid to flow inside them. Corrosive or conductive fluids, such as seawater , certain industrial chemicals, and bleach or bleach-containing products, etc., can cause a short circuit.

## FUNCTIONAL DESCRIPTION

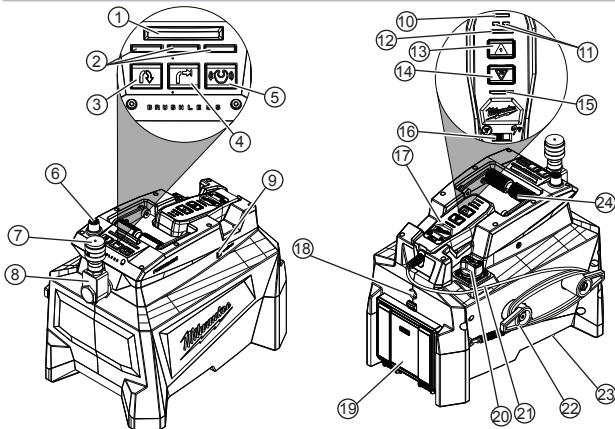

1. Beacon Light
2. Mode Lights
3. Auto-Dump Mode Button
4. Hold Pressure Mode Button
5. Wireless Mode Button
6. Manual Release Button
7. Coupler
8. Coupler Swivel
9. ONE-KEY™ Indicator
10. Bluetooth Light
11. Pressure Indicators
12. Light 1 (Wireless Mode)
13. Advance Button
14. Retract Button
15. Light 2 (Wireless Mode)
16. Wireless Power Switch
17. Remote
18. Oil Reservoir Sight Line
19. Battery Bay
20. Oil Fill Cap
21. Cord
22. Cord Wrap
23. Vent
24. Carry/Lifting Handle

## SYMBOLLOGY

- V** Volts
- |—|** Direct Current
- ⚡** **⚠WARNING** To reduce the risk of arc flash, electric shock and property damage, work on deenergized lines when possible. Tool is not insulated. Should work on energized lines be required, ensure all proper precautions, including those contained in NFPA 70E, have been taken first.
- Read operator's manual.
- Wear safety goggles.
- Danger of compression injury
- IP54** Ingress Protection
- Do not dispose electric tools, batteries/rechargeable batteries together with household waste material. Electric tools and batteries that have reached the end of their life must be collected separately and returned to an environmentally compatible recycling facility. Check with your local authority or retailer for recycling advice and collection point.
- Regulatory Compliance mark (RCM). This product meets applicable regulatory requirements.

## SPECIFICATIONS

<b>Cat. No.</b> .....	<b>M18 HUP700R</b>
Volts.....	18 V DC
Battery Type.....	M18™
Charger Type.....	M18™
Operating Pressure.....	10,000 psi max. (700 bar max.)
Ingress Protection.....	IP54
Recommended Ambient Operating Temperature.....	-17°C to 50°C (0°F to 122°F)
Dimensions.....	
Length.....	401 mm
Width.....	292 mm
Height.....	353 mm
Weight.....	13.5 kg
Usable Oil Reservoir Capacity at 0° Tip.....	1.3 l
Maximum Tip Angle.....	34°
Nominal Flow Rate.....	
Low Pressure.....	2.05 l/min
High Pressure.....	0.42 l/min
Optimal Oil Kinematic Viscosity(40°C).....	24.7mm <sup>2</sup> /s

## ASSEMBLY

**⚠WARNING** Recharge only with the charger specified for the battery. For specific charging instructions, read the operator's manual supplied with your charger and battery.

### Removing/Inserting the Battery

To **remove** the battery, open the battery door, push in the release buttons and pull the battery pack away from the tool. Close battery door.

**⚠WARNING** Always remove battery pack before changing or removing accessories.

To **insert** the battery, open the battery door, slide the pack into the body of the tool. Make sure it latches securely into place. Close battery door.

**NOTE:** For optimal functionality, use M18™ REDLITHIUM®-ION 8.0 Ah battery or higher.

**WARNING** Only use accessories specifically recommended for this tool. Others may be hazardous.

### Removing the Vent Plug

Before using the tool, ensure the vent plug is removed.

#### To remove the vent plug:

1. Open the oil fill cap.
2. Wait five seconds, then close the fill cap.
3. Push the black collar of the vent up and pull the red plug out.

**NOTE:** The plug should be kept to aid in transporting and servicing the tool (see Transport section).

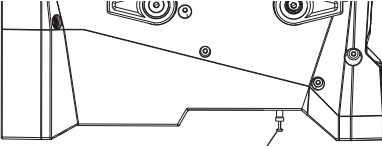

Vent Plug

### Inserting Oil

For best performance, always use Hydraulic Oil to refill the reservoir.

1. Place the tool on a flat, level surface.
2. Twist open the oil fill cap.
3. Insert oil, monitoring the level through the oil sight line.

**NOTE:** The proper oil fill level is half way through the oil sight line (0.71). Excess oil will flow out through the pump vent.

### Removing/Replacing the Coupler

**WARNING** Follow the accessory manufacturers' installation instructions. Other uses may cause damage to the tool, accessories, and workpiece.

#### To remove the coupler:

1. Remove the battery pack.
2. Push and hold down the manual release button for five seconds.
3. Place a wrench on the coupler swivel to steady swivel.
4. Place a second wrench on the coupler and loosen coupler.
5. Once removed, clean out any thread tape still in the coupler area.

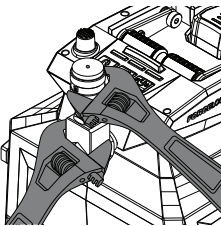

**WARNING** Only use couplers that are rated 10,000 psi (700 bar) or higher.

#### To replace the coupler:

1. Remove the battery pack.
2. Ensure the new coupler has thread tape. If it does not, place two wraps of tape on the threads of the coupler.

**NOTE: Only use thread tape.**

3. Place a wrench on the coupler swivel to steady swivel.
4. Place the coupler onto the coupler swivel and, using a second wrench, tighten the coupler into place.

**NOTE:** The coupler should be torqued to 61 - 74 Nm.

### Priming the Hydraulic System

The tool should be primed any time that it has run dry of oil.

#### To prime the system:

1. Remove the battery pack.
2. Inspect the oil sight line and ensure the tool has enough oil.
3. Connect the coupler to an accessory head that will siphon out the air and excess oil.

**NOTE:** The coupler must be pointed straight up, and the tool must be positioned lower than the accessory head.

4. Insert the battery pack.
5. Press the hold pressure  button.
6. Run the tool.

**NOTE:** It may take up to thirty seconds for air and oil to start coming out.

7. Once the oil starts coming out, press and hold the manual release button for two seconds, then release both buttons.
8. Repeat steps 5-7 three to four times.

**NOTE:** While priming the system, make sure the oil level does not drop below the oil sight line. Refill the reservoir if necessary.

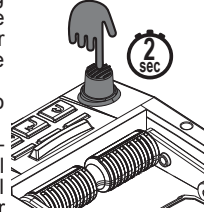

### Bleeding the Accessory

Accessories should be bled of air any time an accessory has been serviced, unused for a long period of time or is connected to a hose that is not pre-filled with oil. Please also consult accessory manufacturer's recommendations for further bleeding instructions.

#### To bleed an accessory:

1. Remove the battery pack.
  2. Connect the accessory hose to the coupler.
- NOTE:** The coupler must be pointed to the side, and the tool must be positioned higher than the accessory hose and head.
3. Insert the battery pack.
  4. Press the hold pressure  button.
  5. Run the tool until the cycle completes, and the pressure indicator lights green.
  6. Press and hold the manual release button for two seconds, then release both buttons.
  7. Repeat steps 4-6 three to four times.

**NOTE:** While bleeding the accessory, make sure the oil level does not drop below the oil sight line. Refill the reservoir if necessary.

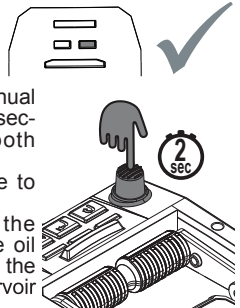



### Removing/Attaching the Remote Cord

To **remove** the remote cord, twist the cord grommet loose and pull the cord away from the remote or tool. To **attach** the remote cord, line up the keys of the cord to the keys of the remote or tool. Push the cord into the remote or tool and twist the cord grommet until tight.

## Selecting Mode

The pump features three modes of operation:

**Auto-Dump mode**  unloads pump pressure as soon as 10,000 psi is reached.

**Hold Pressure mode**  holds pressure until the manual release button is pushed or the retract button is pushed on the remote.

**Wireless mode**  allows the user to activate the pump via bluetooth signal. The pump will run to full pressure and then release. The remote must be re-attached for the next application.

### ONE-KEY™

To learn more about the ONE-KEY™ functionality for this tool, please reference the Quick Start guide included with this product or go to [www.milwaukee.com.au/one-key](http://www.milwaukee.com.au/one-key) To download the ONE-KEY™ app, visit the App Store or Google Play from your smart device.

#### ONE-KEY™ Indicator

Solid Blue	Wireless mode is active and ready to be configured via the ONE-KEY™ app.
Blinking Blue	Tool is actively communicating with the ONE-KEY™ app.
Blinking Red	Tool is in security lockout and can be unlocked by the owner via the ONE-KEY™ app.

## OPERATION

**⚠WARNING** To reduce the risk of arc flash, electric shock and property damage, work on de-energized lines when possible. Tool is not insulated.   
Should work on energized lines be required, ensure all proper precautions have been taken first.

To reduce the risk of injury, always wear proper eye protection marked to comply with ANSI Z87.1.



Before using:

- Inspect pump, hoses, couplers, and fittings for wear or damage. Replace worn, damaged, or missing components with manufacturer's replacement parts.



**WARNING!** Do not use hands to check for leaks. High pressure oil easily punctures skin, causing serious injury, gangrene, or death. If injured, seek medical help immediately to remove oil.

- Ensure pump is in the desired mode of operation.
- Ensure pump is below the maximum tilt angle.
- Check the oil level and adjust if necessary. Low oil may result in injury or property damage. For best performance, always use Hydraulic Oil to refill the reservoir.
- Follow accessory manufacturers' installation instructions. Other uses may cause damage to the tool, accessories, and workpiece.
- Bleed the system if necessary.

To operate with the remote cable-connected to the pump:

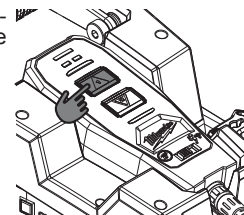
1. Depressurize the tool by holding down the manual release button for five seconds.
2. Insert the battery pack.
3. Connect the hose coupler to the pump coupler.
4. Connect the tool head to the hose.
5. Press and select the preferred mode of operation between auto-dump  and hold pressure .

6. Press and hold the advance button  on the remote. 

7. If in auto-dump mode , the pump will release pressure as soon as 10,000 psi is reached. The pump will switch off and the indicator will light. 

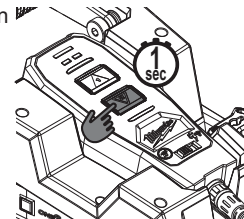
8. Press the retract button  for one second. 

Light Indicator	Definition
Solid Green	Tool reached full pressure.
Solid Red	Tool did not reach full pressure.
Continuous Flashing Red/Green (after Solid Green or Solid Red)	Tool has reached its service interval (20,000 crimps). Red/Green flashing will begin after the solid Red or Green indicator for the operation is displayed. MILWAUKEE® recommends that the tool be inspected and preventative maintenance completed. Return tool to a MILWAUKEE® service facility.
Short Flashing Red/Green	Tool has malfunctioned and can no longer be used until it is serviced. Return tool to a MILWAUKEE® service facility.

**NOTE:** If the indicator shows red, check the oil levels and ensure that there are no leaks in the attachments. Confirm that all connections are secure and the attachments are secure. Repeat the steps under "Operation". If the problem persists, return the tool to a MILWAUKEE® service facility.

To operate in Wireless mode:

1. De-pressurize the tool by holding down the manual release button for five seconds.
2. Insert the battery pack.
3. Connect the hose coupler to the pump coupler.
4. Connect the tool head to the hose.
5. Disconnect the remote from the cable and remove it from the pump.

6. Press the wireless mode button  on the pump.

The beacon light will flash red.

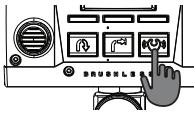



Light Indicator	Definition
Solid Green	Tool reached full pressure.
Solid Red	Tool did not reach full pressure.

7. On the remote, turn the wireless power switch on .

The bluetooth light will flash blue, then turn solid when connected.

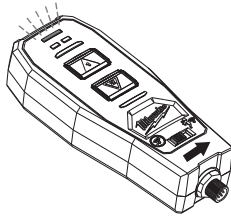
Once connected, light 1 will flash red.



8. Press and hold the advance button  for approximately three seconds.

Light 1 will turn steady red.

Release the advance button .

Light 2 will flash red.

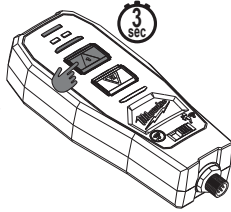

**NOTE:** This step must be done within five minutes of activating wireless mode.

9. Press and hold the retract button  for approximately three seconds.

Light 2 will turn steady red.

Release the retract button . Initiation will begin.

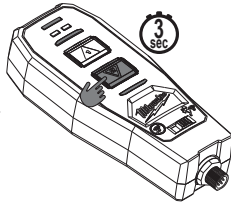

**NOTE:** This step must be done within twenty seconds of the advance button  being pressed.

10. When the cycle is complete, the cut indicator will light:

Green (right) = Full pressure reached

Red (left) = Full pressure NOT reached



**NOTE:** If the indicator shows red, check the oil levels and ensure that no leaks are happening in the at-tachments. Confirm that all connections are secure and the attachments are proper for the job. Repeat the steps under “Operation”. If the problem persists, return the tool to a **MILWAUKEE**® service facility.

## MAINTENANCE

**AWARNING** To reduce the risk of injury, always unplug the charger and remove the battery pack from the charger or tool before performing any maintenance. Never disassemble the tool, batterypack or charger. Contact a **MILWAUKEE**® service facility for ALL repairs.

### Maintaining Tool

Keep your tool, battery pack and charger in good repair by adopting a regular maintenance program. Inspect your tool for issues such as undue noise, misalignment or binding of moving parts, breakage of parts, or any other condition that may affect the tool operation. Return the tool, battery pack, and charger to a **MILWAUKEE**® service facility for repair. After six months to one year, depending on use, return the tool, battery pack and charger to a **MILWAUKEE**® service facility for inspection. If the tool does not start or operate at full power with a fully charged battery pack, clean the contacts on the battery pack. If the tool still does not work properly, return the tool, charger and battery pack, to a **MILWAUKEE**® service facility for repairs.

### Service Interval

Refer to the ONE-KEY App for information regarding necessary servicing, such as fluid replacement. Return the tool to a **MILWAUKEE**® service facility for all repairs and maintenance.

**NOTE:** The week and year of tool manufacture may be needed. This information can be found on the serial number located on the tool nameplate.

CODE: 

YEAR	WEEK
K15AD	XXXXXXXXXX

### Transport

Before transporting:

- Depressurize the tool by holding down the manual release button for five seconds.
- Drain the tool of oil and dispose of oil in accordance to local law and regulations.
- Plug the vent.
- Wrap the tool in plastic to prevent any remaining oil spillage.

## ONE-KEY™

### **AWARNING** Chemical Burn Hazard.

This device contains a lithium button/coin cell battery. A new or used battery can cause severe internal burns and lead to death in as little as 2 hours if swallowed or enters the body. Always secure the battery cover. If it does not close securely, stop using the device, remove the batteries, and keep it away from children. If you think batteries may have been swallowed or entered the body, seek immediate medical attention.



### Internal Battery

An internal battery is used to facilitate full ONE-KEY™ functionality.

To replace the battery:

1. Remove the battery pack.
2. Remove the screw(s) and open the battery door.
3. Remove the old battery, keep it away from children, and dispose of it properly.
4. Insert the new battery (3V CR2032), with the positive side facing up.
5. Close the battery door and tighten the screw securely.

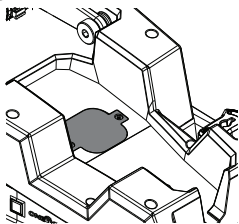

### Remote Batteries

Four AAA batteries are used to facilitate full remote functionality.

**NOTE:** AAA batteries are not required while connected to the pump.

To replace the batteries:

1. Remove the battery door screws on the back of the remote. Remove battery door.
2. Insert four AAA batteries according to the polarity marked in the battery compartment.
3. Close the battery door and reinsert the screws, tightening securely.

**AWARNING** To reduce the risk of personal injury and damage, never immerse your tool, battery pack or charger in liquid or allow a liquid to flow inside them.

### Cleaning

Clean dust and debris from vents. Keep handles clean, dry and free of oil or grease. Use only mild soap and a damp cloth to clean, since certain cleaning agents and solvents are harmful to plastics and other insulated parts. Some of these include gasoline, turpentine, lacquer thinner, paint thinner, chlorinated cleaning solvents, ammonia and household detergents containing ammonia. Never use flammable or combustible solvents around tools.

### Repairs

For repairs, return the tool, battery pack and charger to the nearest service centre.

**NOTE:** Wrap the pump in plastic before shipping.

### ACCESSORIES

**AWARNING** Use only recommended accessories. Others may be hazardous.

Only use hoses and attachments that are single-acting and rated 10,000 psi (700 bar) or higher. For a complete listing of accessories, go online to [milwaukeeetool.com.au](http://milwaukeeetool.com.au) / [milwaukeeetool.co.nz](http://milwaukeeetool.co.nz) or contact a distributor.

## WARRANTY - AUSTRALIA and NEW ZEALAND

Please refer to Australian and New Zealand warranty supplied with tool. This warranty applies only to product sold in Australia and New Zealand.

## SERVICE - AUSTRALIA and NEW ZEALAND

MILWAUKEE® prides itself in producing a premium quality product that is Nothing But Heavy Duty®. Your satisfaction with our products is very important to us! If you encounter any problems with the operation of this tool, please contact your authorised MILWAUKEE® dealer.

For a list of MILWAUKEE® dealers, guarantee or service agents please contact MILWAUKEE® Customer Service or visit our website.

(Australia Toll Free Telephone Number 1300 645 928)

(New Zealand Toll Free Telephone Number 0800 645 928)

or visit [milwaukeeetool.com.au](http://milwaukeeetool.com.au) / [milwaukeeetool.co.nz](http://milwaukeeetool.co.nz).

### Milwaukee Electric Tool Corporation

13135 West Lisbon Road, Brookfield, Wisconsin U.S.A. 53005

#### Milwaukee Tool (Australia)

21 Kelletts Road, Rowville, VIC 3178  
Melbourne, Australia

#### Milwaukee Tool (New Zealand)

274 Church Street, Penrose,  
Auckland, 1061, New Zealand

Designed by Milwaukee Electric Tool Corp.

Professionally Made in China for Milwaukee Tool (Australia) / Milwaukee Tool (New Zealand)

Printed in China